

Intuy Knee

Instructions for Use (EN)

[Original Instructions]

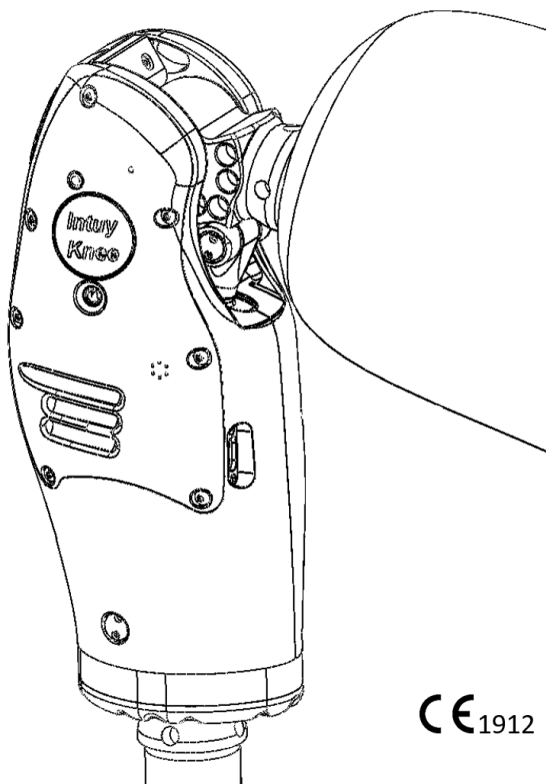

CE₁₉₁₂

Intuy Knee

Instructions for Use **(EN)**

[Original Instructions]

Electronic Instructions for Use in different languages are available on the Manufacturer's website (www.rbionics.com). Instructions for Use in paper format can be requested from the website at no additional cost and shall be delivered within 7 calendar days.

This document is subject to change, please contact the local Representative of the Manufacturer or visit the Manufacturer's website to obtain the latest version.

TABLE OF CONTENTS

Table of Contents	3
Terms and Abbreviations	6
Safety Warnings in this Document	6
General Warnings	6
1. Introduction	9
1.1. Intended Use	9
1.2. Symbols Used on the Device and in this Document	11
1.3. Product Labels	12
2. Product description	13
2.1. Dimensions (in Millimeters) and Description of Key Elements	13
2.2. Product Model Identification	14
2.3. The Knee Cover	14
2.4. Scope of Delivery	14
2.5. Product Technical Data	14
3. Installation	17
4. Mobile App for the Knee	17
4.1. System Requirements on Mobile Devices	17
4.2. How to Obtain the App	17
4.3. Personal Account for the App	17
4.4. The User Interface (UI) of the App	18
4.5.  Software Update	19
5. Preparation for Use	20
5.1 First Use and Hibernation Mode	20
5.2. Power On	20

	Instructions for Use (Wearer)		DOC-66
	Basic UDI-DI: 87202994598ILK98	Ver. 2.0.7, 2022/11/04	4 / 35

5.3. Power Off	21
5.4. Check Battery Status	21
5.5. Charging the Device	21
6. Default Modes and Routines.....	22
6.1. High-Resistance Mode (HR-mode)	22
6.2. Low-Resistance Mode	22
6.3. Error Routine	22
6.4. Battery Low Routine.....	23
7. Operation Instructions	23
7.1. From Sleep mode to Operation mode.....	23
7.2. Standing State	23
7.3. Sitting Down and Standing Up.....	24
7.4. Walking	24
7.5. Descending Stairs and Ramps	25
7.6. Ascending Stairs	26
7.7. Kneeling Down and Getting Up	26
7.8. Cycling	27
8. Information Signals of the Device	28
9. Troubleshooting Guide	30
10. Maintenance, Transportation, Storage, and Disposal	31
10.1. Manufacturer Maintenance	31
10.2. User Maintenance and Cleaning	31
10.3. Transportation and Storage	32
10.4. Disposal	32
11. Warranty, Service Life, Liability, and Incident Reporting	32

11.1. Warranty and Service Life	32
11.2. Liability	33
11.3. Serious Incident Reporting	33
12. Product Certification Information	33
12.1. EN-IEC 60601-1:2006+AC:2010+A1:2013+A12:2014	34
12.2. EN-IEC 60601-1-2:2015	34
12.3. EN ISO 10328:2016.....	34
12.4. Bluetooth Module	34
13. Contact Information.....	34
13.1. Manufacturer	34
13.2. Distributor or Retailer	35

TERMS AND ABBREVIATIONS

EU	The European Union
HR-mode	High-resistance mode
IFU	Instructions for use
ILK	Intuy Knee
QMS	Quality Management System
RF	Radio Frequency
RH	Relative Humidity
UI	User Interface

SAFETY WARNINGS IN THIS DOCUMENT

⚠ WARNING: Statement regarding possible risks of severe accident or injury.

⚠ CAUTION: Statement regarding possible risks of accident or injury.

Precaution: Statement regarding possible damages to the device.

GENERAL WARNINGS

⚠ WARNING: Read this document carefully before using the device independently.

⚠ WARNING: Practice operating the prosthesis in the presence of a trained professional before using it independently. Start using the prosthesis independently only when authorized to do so.

⚠ WARNING: Do not modify the product. Li-ion battery is inside. Fire or explosion can occur and cause bodily damage. Any modification to the product will void the warranty.

⚠ WARNING: Incorrect combination of components (e.g., the foot prosthesis) can cause bodily damage.

⚠ WARNING: Follow the recommended maintenance intervals. Not maintaining the product timely can cause damage to the device and the user, and will void the warranty.

⚠ WARNING: Power off the prosthesis when performing tasks that may be critical to your safety, such as driving a motor vehicle or operating other potentially dangerous machinery.

⚠️ WARNING: Stop walking immediately whenever a signal is felt (prosthesis vibrates) and/or heard (prosthesis beeps).

⚠️ WARNING: Always use the handrail when traversing stairs or slopes. Do not traverse stairs and slopes when handrails are not present.

⚠️ WARNING: Use of components and cables other than those specified or provided by the manufacturer could result in increased electromagnetic emissions or decreased electromagnetic immunity of this equipment and result in improper operation.

⚠️ WARNING: Portable RF communications equipment (including peripherals such as antenna cables and external antennas) should be used no closer than 30 cm (12 inches) to any part of the Knee and the charger, including the supplied cables specified by the manufacturer. Otherwise, degradation of the performance of this equipment could result.

⚠️ WARNING: It is not allowed to expose the device to strong electromagnetic disturbances, e.g., to an MRI machine. The device might stop functioning when exposed.

⚠️ WARNING: It is not allowed to use the device in an oxygen-rich environment or an area containing flammable (anesthetic) gases.

⚠️ CAUTION: Keep body parts away from moving parts; moving parts may cause injury.

⚠️ CAUTION: Use the prosthesis at temperatures between -10°C and $+40^{\circ}\text{C}$.

⚠️ CAUTION: Charge the prosthesis at temperatures between 0°C and $+40^{\circ}\text{C}$.

⚠️ CAUTION: Power on the prosthesis only when you are wearing it.

⚠️ CAUTION: Walk with the device only when it is powered on.

⚠️ CAUTION: Do not apply loads higher than the specified rating.

⚠️ CAUTION: Do not charge other devices with the charger!

⚠️ CAUTION: Always exercise good judgment and common sense when using the knee and components (e.g. the charger), limit their utilization to the use they were designed for, and follow the instructions provided in this document.

⚠️ CAUTION: Visually inspect the prosthesis before each use. Make sure that no component of the prosthesis or accessories has been altered or tampered with.

⚠️ CAUTION: If you experience any problems with a component of the prosthesis or accessories, contact your prosthetist first. Never attempt to make any

	Instructions for Use (Wearer)		DOC-66
	Basic UDI-DI: 87202994598ILK98	Ver. 2.0.7, 2022/11/04	8 / 35

technical repairs yourself.

⚠ CAUTION: If the knee Cover needs to be replaced, contact your prosthetist. Never attempt to remove the knee Cover by yourself.

Precaution: Avoid high-impact activity and sports, excessive loading, and heavy-duty use.

Precaution: Avoid exposure to rain, snow, ice, or salt. Maintain and store in clean and dry condition.

Precaution: Avoid exposure to intense dust or smoke or to excessive mechanical shocks or vibrations.

Precaution: Avoid spillage or immersion in water or any other fluids.

Precaution: The charger is for indoor use only.

1. INTRODUCTION

The Intuy Knee (hereafter referred to as the Device, the Knee, Joint, or ILK) is a motorized external knee prosthesis designed to actively assist leg amputees in performing daily activities. It is an active-power electromechanical device, which is a component of an external lower limb prosthesis designed to functionally replace, in part or total, an absent knee.

Please read this document thoroughly and discuss any questions with your prosthetist before using this device. To ensure the safe and proper operation of the device, you must follow the instructions provided in this document and obtain sufficient training given by a professional.

1.1. INTENDED USE

According to EN ISO 14971:2019* cl. 3.6, Intended use and intended purpose are interchangeable.

The device is intended to actively assist above-knee amputees and hip- or knee-disarticulation individuals in performing daily activities such as

- standing
- walking
- stair and slope ascending and descending
- sitting down and standing up
- kneeling

The mobile app is used to adjust the settings and switch the operational modes of the device.

Intended Population

The intended user group is summarized below.

- **Clinical status:** (unilateral or bilateral) knee disarticulation, transfemoral amputation, and hip disarticulation.
- **Bodyweight:** Between 25 and 125 kg
- **Body height:** Between 1.20 and 1.95m
- **Age:** No specific requirement is indicated. It should be evaluated based on the physical and mental conditions of the user by care providers.

Intended User Profile

The device is intended for amputees with moderate to high activity levels.

This device is installed and customized by a qualified prosthetist. Prosthetists

become the user when integrating the device to construct a leg prosthesis and adjust settings for the amputees.

Intended Medical Indication

The device is indicated for individuals with (unilateral or bilateral) knee disarticulation, transfemoral amputation, and hip disarticulation. The individual must fulfill the physical and mental requirements for perceiving visual/acoustic signals and/or mechanical vibrations.

Limitations and Contraindications

Bilateral amputees might not be able to perform all the activities indicated in this document, such as step-over-step stair ascent or cycling.

There is not enough clinical data to encourage or discourage the use of the device for users with osseointegration.

Similarly, there is not enough clinical data to encourage or discourage the use of the device for patients with low mobility levels.

Due to possible socket stability issues, a patient with a short stump might not enjoy all the benefits of the device, e.g., step-over-step stair climbing. However, a patient with a short stump is not discouraged to use this device.

Currently, there is no known contraindication.

Part of the Body Interacted with

Via a prosthetic socket, the device shall be connected to the residual limb of the user. The prosthetic socket is mostly made of non-conducting plastics. Very often, the user also puts on a silicon or other non-conductive material-based liner before putting it on the socket.

The user will only shortly touch the device when donning the prosthetic leg on/off, power on/off the device, and (dis-)connecting the charger cable.

Besides that, there is no direct contact during use.

Intended Use Environment

The device actively assists amputees in performing daily activities in Home Healthcare Environment (see EN-IEC 60601-1-11:2015), the device will be used both indoors and outdoors.

- **Temperature range:** -10°C to 40°C
- **Humidity:** 0% to 90% RH, non-condensing
- **Air pressure:** 700-1060hPa

The charger is to be used indoors only.

- **Temperature range:** 0°C to 40°C
- **Humidity:** 0% to 90% RH, non-condensing

	Instructions for Use (Wearer)		DOC-66
	Basic UDI-DI: 87202994598ILK98	Ver. 2.0.7, 2022/11/04	11 / 35











- **Air pressure:** 700-1060hPa

Reasonably Foreseeable Misuse



The foreseeable misuses are listed below.

- The user exposes the device to rain, snow, ice, and salt.
- The device is subject to spillage or immersion in water or any other fluids, e.g., taking a shower while wearing the device
- The user exposes the device to intense dust.
- The user exposes the device to excessive mechanical shocks or vibrations.
- Use in highly electrical and/or magnetic environments (e.g., electrical transformers, high-power radio/TV transmitters).
- The user uses the device for high-impact activities and sports.

1.2. SYMBOLS USED ON THE DEVICE AND IN THIS DOCUMENT

Max. 125kg	Maximum user weight (125kg)
	Caution: danger! Keep body parts such as fingers away
	Medical device
	Caution: consult the Instructions for Use
	Manufacturer information
	Year of manufacturing
	Direct Current
	Power button
	Non-ionizing radiation
	CE label
	Serial number
MN	Model number
IP45	Protection against >1 mm particles, protection against water jets
	Follow Instructions for Use



	Instructions for Use (Wearer)		DOC-66
	Basic UDI-DI: 87202994598ILK98	Ver. 2.0.7, 2022/11/04	12 / 35

	The product should not be discarded as unsorted waste but must be sent to separate collection facilities for recovery and recycling. Please observe the instructions in this document.
	Distributor

NOTE: To see some of the symbols used on the device, please remove the Knee Cover carefully. Removal of the cover shall be done by qualified personnel such as your prosthetist.

1.3. PRODUCT LABELS

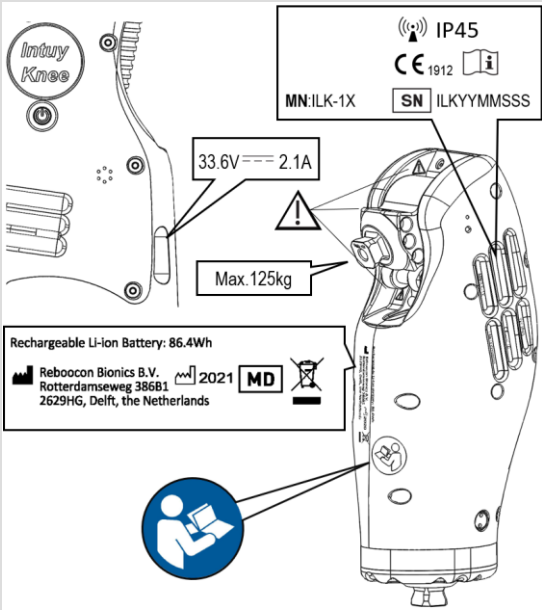
Labels are present on the Device and the Charger. Device labels are laser engraved onto the metal frame and Charger labels are stickers.

 <p>Device Label</p>	 <p>Charger Label</p>
--	--

2. PRODUCT DESCRIPTION

2.1. DIMENSIONS (IN MILLIMETERS) AND DESCRIPTION OF KEY ELEMENTS

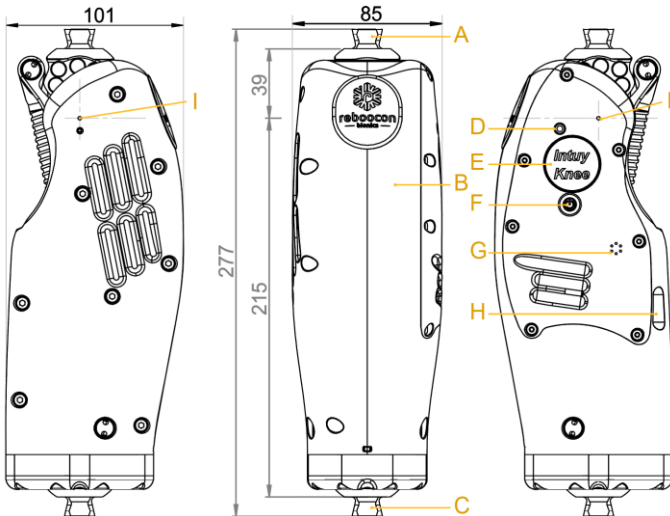

Key functional elements of the device are shown in the figure above and listed below (**note:** the knee Cover is removed for clarity):

- A. Top pyramid, a standard prosthetic interface for connecting to thigh socket.
- B. The Knee body, consists of the following components: the frame, the battery, the electronics, and the actuator unit.
- C. Bottom pyramid, a standard prosthetic interface for connecting to the tube adapters.

On the device body, the following elements can interact with the user

- D. A dual-color (amber/green) LED set to indicate the working status of the device;
- E. Bluetooth for communicating with smartphones;
- F. A power button, to power on and off the device.;
- G. A buzzer, together with the LEDs to indicate the status of the device;
- H. A charging port, a standard USB-C receptacle connector;
- I. The Knee Axis marks on both sides for prosthetic alignment.

	Instructions for Use (Wearer)		DOC-66
	Basic UDI-DI: 87202994598ILK98	Ver. 2.0.7, 2022/11/04	14 / 35

2.2. PRODUCT MODEL IDENTIFICATION

There are two models: ILK-1B and ILK-1W (see label on the device). ILK-1B refers to the black model and ILK-1W refers to the silver model. There is no other difference besides color. In some countries, only one model is available.

2.3. THE KNEE COVER

The Knee comes with a protective cover, which has the following functions:

- Protects the device from debris and dust
- Protects the user's fingers from pinching hazards (refer to General Warnings)
- Slightly reduces the noise

The cover must be replaced if it's worn out, damaged, or broken. Contact your prosthetist to get a replacement.

2.4. SCOPE OF DELIVERY

The following components are delivered:

- 1 pc. Knee device
- 1 pc. Battery charger (including 1 pc. C7 power cord, ILKCH)
- 1 pc. Instructions for use (Wearer)
- 1 pc. USB stick
- 1 pc. T-wrench
- 1 pc. Knee cover
- Android/IOS app Intuy

2.5. PRODUCT TECHNICAL DATA

<i>Environmental Conditions</i>	
Transportation in original packaging	0°C to 40°C, max.90% RH, non-condensing
Transportation without packaging	0°C to 40°C, max.90% RH, non-condensing
Storage (≤ 3 months)	0°C to 40°C, max.90% RH, non-condensing
Long-term storage (> 3 months)	0°C to 20°C, max.90% RH, non-condensing
Operation	-10°C to 40°C, max.90% RH, non-condensing

	Instructions for Use (Wearer)		DOC-66
	Basic UDI-DI: 87202994598ILK98	Ver. 2.0.7, 2022/11/04	15 / 35

Charging the battery	0°C to 40°C, max.90% RH, non-condensing
----------------------	---

Intuy Knee device

Weight	2.4 kg
Range of motion	Max flexion 120°, max extension 0°
Maximum output torque	100Nm
Maximum output power	600W
Protection rating	IP45 (protection against >1 mm particles & water jets)
Range of Bluetooth connection	Max. 10 m
Bluetooth RF receiver	Frequency band: 2.4 GHz. Bandwidth: 83.5 MHz
Bluetooth RF transmitter	Frequency band: 2.4 GHz. Modulation: GFSK. Power: 8 dBm

Battery (built-in, non-removable)

Battery type	Li-ion
Battery nominal voltage	28.8 VDC
Battery Capacity	3.0 Ah
Battery Energy	86.4 Wh
Nominal charging current	2.1 A
Rated (max) charging current	2.4 A
Full charge voltage	33.6 VDC
Battery fuse rating (rated voltage, rated current, interrupting rating)	35 VDC, 40 A, 300 A
Charging cycles (80% original battery capacity remaining)	500

Product behavior when charging	Disabled
Operating autonomy	44h use-dependent

Battery charger

Model number	LYD703362000
Weight	0.27 kg
Dimensions	12 cm x 3.7 cm x 5.4 cm
Rated input voltage	100 - 240 VAC
Input frequency	50/60 Hz
Max input current at rated input voltage	1.5 A
Output voltage (end-of charge)	33.6 VDC \pm 1%
Rated charge current	1.78 A \pm 10%
Supply cord length (a.c. port)	0.8 m
Storage & transport environment	0°C to 40°C, max.90% RH, non-condensing
Operation environment	0°C to 40°C, max.90% RH, non-condensing
Protection rating	IP20

Structural Strength (tested according to EN-ISO 10328: 2016)

Load Level	P6, max. 125kg
Fatigue strength (3 million cycles)	150kg
Static proof strength	250kg
Ultimate strength	400kg

	Instructions for Use (Wearer)		DOC-66
	Basic UDI-DI: 87202994598ILK98	Ver. 2.0.7, 2022/11/04	17 / 35
Static strength in torsion (30s)		50Nm	
Static ultimate strength in max. knee flexion		175kg	

3. INSTALLATION

Installation of the Knee is not meant to be executed by the patient. Installation is only done by qualified personnel.

For the Installation Instructions, refer to [DOC-68 Instructions for Use \(Practitioner\)](#).

4. MOBILE APP FOR THE KNEE

4.1. SYSTEM REQUIREMENTS ON MOBILE DEVICES

- Operating system: Android 10.0 or above, iOS 13.6 or higher
- RAM: 2 GB or more
- Internal Storage: 10 MB for app installation/ 1024 MB for diagnostic data storage
- Bluetooth: Bluetooth 4.0 or higher
- Screen: touch screen, 4 inches or bigger
- Network: WiFi or mobile network enabled

4.2. HOW TO OBTAIN THE APP

Search for "Intuy by Rebocon" in the [Play Store](#) on an [Android](#) device or [App Store](#) on an [Apple](#) device and install it. The app will be made available to more app stores. Alternatively, use this link: <https://www.rbionics.com/app/>.

4.3. PERSONAL ACCOUNT FOR THE APP

It is required to have a personal account to use the app. The account is invitation based. The Manufacturer or the local Representative of the Manufacturer should send an invitation to the potential users (both professional and end users).

Instructions about logging in are given in the (email) invitation. After logging in, the app can be used.

Different user accounts have different authorization levels. The higher the authorization level, the more app features the user can access. With a personal





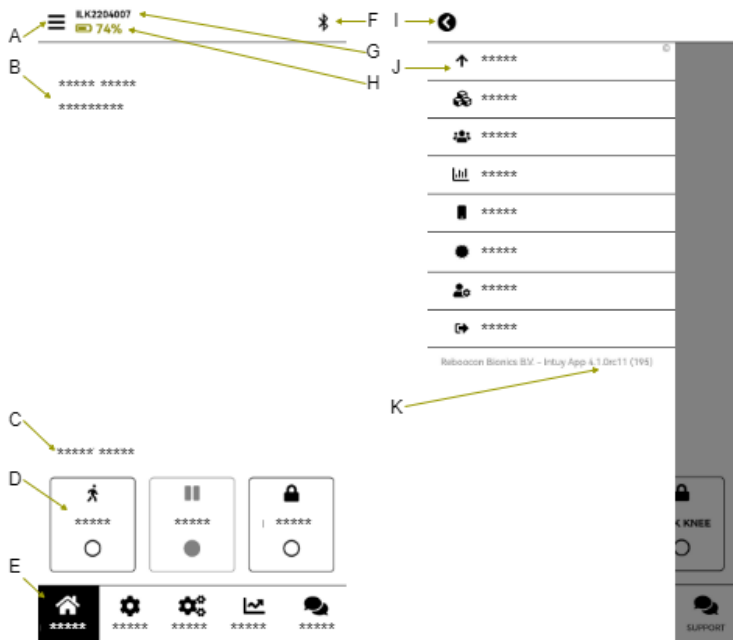







account, the user can connect to a Knee authorized to him/her and store personalized settings on the app server.

4.4. THE USER INTERFACE (UI) OF THE APP



The **DASHBOARD** tab (the main UI) is shown in the left picture above. The key elements:

- A. **☰ Menu button**: when clicked, the picture on the right shows up. It has a return button **(I)** and you can see the app version **(K)**. When clicking the individual Menu Items **(J)**, diverse pages for different purposes pop up:
 - **↑ Update**: manage Knee firmware update and app update;
 - **🔧 Device management ***: manage all the devices authorized to you, e.g., authorizing others to use the device in the list;
 - **👤 User management ***: manage all the users under your authorization;
 - **📊 Statistics**: check the daily and total steps, stairs count, etc.;

-  **App settings**: e.g., change the server settings or other settings of the app;
 -  **My account**: manage your own account information, e.g., change password or email;
 -  **Log out** button.
- B. **Notification Center**: it shows error messages or notifications such as software updates or periodic maintenance deadlines.
- C. **Device Status**: It indicates the current mode of the device, such as cycling or sitting.
- D. **Mode Switching Buttons**, from left to right:
-  **START**: switch the Knee to operational mode, the user can walk with the Knee;
 -  **SLEEP**: switch the Knee to sleep mode, the motor of the Knee is shut down, and no support is given;
 -  **LOCK KNEE**: fully extend the Knee and lock it.
- E. **Function tabs**: each tab has its own function, with its contextual buttons and fields. From left to right:
-  **DASHBOARD**: this shows the dashboard, as shown in the picture on the left;
 -  **SETTINGS**: here patient data can be set and sent to the Knee, such as body weight, height, and segment lengths;
 -  **EXTRA** *: here extra parameters for walking, stairs, etc. can be customized, if the default settings are not ideal;
 -  **GRAPH** *: it shows the knee torque, knee angle, etc. in real-time;
 -  **SUPPORT**: data from the Knee and app use are collected and can be sent to the Manufacturer's server for troubleshooting purposes;
- F.  **Bluetooth**: a new page will pop up when clicked to allow the user to connect or disconnect to a Knee.
- G. **ILKymmxxx**: it shows the serial number of the device.
- H.  **Battery**: battery level.

* Not available for the patient.

4.5. SOFTWARE UPDATE

The app checks whether the app itself or the firmware in the Knee is up-to-date.

To update, click the item **↑ Update** in the **☰ Menu**. On the update page, click the update button if an update is available. An app update is straightforward and relatively quick. A firmware update typically takes 5 to 20 minutes. Don't perform any other activities on the phone. If the firmware update fails, retry according to the app's instructions.

⚠ WARNING: Sit down or doff the prosthesis when performing the Knee firmware update. Don't use the Knee.

⚠ WARNING: After the firmware update, the Knee is in sleep mode, and the user is required to load the prosthesis sufficiently (>50% bodyweight) before making the first step.

⚠ WARNING: Make sure that the phone has more than 20% charge and that the Knee has more than 40% charge. Keep the Knee and the phone close to each other during the update process.

5. PREPARATION FOR USE

5.1 FIRST USE AND HIBERNATION MODE

Before leaving the factory, the knee is put into Hibernation Mode. To get out of Hibernation Mode, the knee must be charged once. It is not possible to enter Hibernation Mode unless the battery goes extremely low.

5.2. POWER ON

Press and hold the Power Button for 3s, until the buzzer beeps and the green LED flashes. The device then enters Sleep Mode. Load the device by putting half of the body weight on the prosthesis to enter the Operation Mode.

Precaution: Do not hold the Power Button longer than 15 seconds, the knee can be damaged.

⚠ CAUTION: Load the prosthesis sufficiently before standing up or walking. The device does not provide support when powered off, or in sleep mode. Sufficient loading on the device activates the support.

⚠ CAUTION: The knee will enter Sleep Mode if it is standing still and unloaded for 10 minutes. This transition will be indicated with 3 descending beep tones and 1 vibration.

	Instructions for Use (Wearer)		DOC-66
	Basic UDI-DI: 87202994598ILK98	Ver. 2.0.7, 2022/11/04	21 / 35

5.3. POWER OFF

To power off the device, press and hold the power button for 3s. A continuous beep will be audible when the power button is pressed. After 3s, the device will shut down and the amber LED will fast flash until releasing the power button. To save energy, power off the device when not wearing it.

Precaution: Do not hold the Power Button longer than 15 seconds, the knee can be damaged.

⚠CAUTION: Support from the device will suddenly drop when powered off, therefore the user must be seated before powering off the device.

5.4. CHECK BATTERY STATUS

1. When charging, the amber LED lights up and is continuously on.
2. When fully charged, the amber LED goes off and the green LED lights up continuously.
3. When the remaining battery capacity is below 25% or below 12.5%, visual and audible signals and vibrations will be given by the device (refer to the section "Information Signals of the Device").

5.5. CHARGING THE DEVICE

1. Power the device OFF
2. Insert the charger cable into the charge port. The amber LED lights up continuously.
3. It takes about 2 hours to fully charge. Once charged, the green LED lights up continuously.
4. The device will automatically cut off the charging current when fully charged.

⚠WARNING: Do not charge the device in a vehicle (car, bus, train, boat, plane, helicopter).

⚠CAUTION: Do not use the device when it is charging, as it does not provide support when charging.

⚠CAUTION: Do not keep the device battery fully charged when it is not in use for an extended period.

6. DEFAULT MODES AND ROUTINES

The device has two default modes that are only used in error or low-battery state. This includes a high-resistance mode and a low-resistance mode. The following sections describe these modes.

6.1. HIGH-RESISTANCE MODE (HR-MODE)

The high resistance mode (HR-mode) is a mode where the knee joint provides high resistive force in both flexion and extension directions. The knee cannot actively swing or extend anymore. When the HR-mode is used in the fully extended position the Knee can act as a single-axis high-resistance knee joint. It can therefore provide the user with limited ambulation capabilities on level ground. The HR-mode is activated during the device error routine (see section 6.3).

6.2. LOW-RESISTANCE MODE

The device has a low-resistance mode (LR-mode) that is triggered in the following scenarios

1. Critical motor errors and unusable motor;
2. Battery malfunctioning;
3. Critically low battery.

It is accomplished by either shutting down the motor driver or by powering off the whole system.

6.3. ERROR ROUTINE

When a detectable error occurs, the error routine will be initiated. Based on the criticality of the error, either an 8-second beep or a 30-second beep will be produced when the error is triggered.

The 8-second beep is mostly given when the motor of the knee is still usable. Depending on the situation, the following scenarios can happen:

- If the knee is in the swing phase, the knee will extend and then go to HR-mode. The extension speed of the error routine is slower than normal.
- If the knee is in the stance phase, the knee will directly enter the HR-mode.

- If the knee is loaded and flexed, the user should unload the prosthesis. The knee will extend slowly and sound a beep once it enters the HR-mode indicating the error routine is completed.
- If the knee is just powered on, the knee will directly enter HR-mode.

The 30-second beep is sounded for critical errors for which the joint resistance will suddenly drop due to knee shutdown.

In any situation mentioned above, stop using the knee, start the phone app and connect to the device, and contact your prosthetist for support. Provide the information from the app, such as error notifications, to your prosthetist.

6.4. BATTERY LOW ROUTINE

When the battery level drops to 25%, the device will warn the user by beeping and vibrations. The user should charge the device within 30min.

When the battery level drops to 12.5%, the device will warn the user again by beeping and vibrations. The user should then stop and load the prosthesis for 3 seconds to enter the HR-mode. If the user continues to use the knee, it automatically enters HR-mode after 1 minute indicated by 1 beep.

The knee can stay in HR-mode for approximately 30 minutes. If the user fails to charge the device during this period, the knee will power off and provide no support.

7. OPERATION INSTRUCTIONS

The knee supports the majority of activities of daily living. In this section, the operation instructions are given.

7.1. FROM SLEEP MODE TO OPERATION MODE

After powering on the Knee, the Knee is in Sleep mode. Load the Knee by putting half of the body weight on the prosthesis to enter the Operation Mode.

7.2. STANDING STATE

The knee automatically adjusts its operating states e.g. walking, ascending, or descending stairs/ramps. When none of these activities is detected, it operates in a “standing state”. In this state, common day-to-day tasks can be performed, like talking to people, reaching the shelf, and cooking in the kitchen.

In the standing state, the prosthetic knee provides high resistance and support, allowing making small steps in a confined space.

⚠CAUTION: The knee might trigger a small step when there is a foot roll-over. The user can put the foot down and the knee can support the user safely.

7.3. SITTING DOWN AND STANDING UP

To sit down:

1. Stand straight, preferably with both feet parallel to each other.
2. Distribute weight evenly to both legs, load the knee and slowly bend the knee.
3. Sit down as you normally do by moving your center of gravity backward while leaning your trunk forward.
4. The knee joint resistance drops after 3 seconds of sitting down and the knee is free to move.

To stand up:

1. Readjust the position of the prosthetic foot, preferably have both feet parallel to each other.
2. Load the device and distribute weight evenly to both legs.
3. Lean forward and extend the knee. Use the arms to push off if needed.
4. The device automatically assists in standing up until the knees are fully extended.

⚠CAUTION: Load both feet when sitting down and standing up.

7.4. WALKING

Make a step with either leg and start walking. The knee automatically adjusts its behavior in the following ways:

- It provides support whenever ground contact is detected.
- It has an active-swing function to create a dynamical swing phase when the toe is off from the ground.

The knee will adapt the swing phase parameters to the user's self-selected walking speed automatically.

By default, the knee extends to a preflexion angle of 4° at the end of the swing phase. The benefit of a preflexion angle is two-fold:

1. It provides symmetric and natural gait in the stance phase.
2. It provides increased shock absorption that reduces stress on the back.

The flexion angle can be tuned between 0° and 7°.

Make sure to take equal steps. Trust and load the prosthetic leg sufficiently. There is no need to proactively kick the stump forward to bring the knee into extension thanks to the active-swing function.

The walking function can also be used to ascend ramps and descend shallow ramps.

⚠ WARNING: The stair ascent function might get triggered when taking a step on a curb or a raised platform. Do not panic when this happens, flex the hip and then put the foot down and continue walking.

⚠ WARNING: The stair ascent function might get triggered when taking a step on a steep slope. Do not panic when this happens, follow the steps of stair ascent till you put the foot down and continue with slope ascent after.

⚠ WARNING: Always use a handrail or other type of support when ascending or descending slopes.

⚠ CAUTION: When rotating or turning in place, the device may initiate a swing motion. Do not panic when this happens. Bring the leg forward and continue.

7.5. DESCENDING STAIRS AND RAMPS

1. Initiate stair/slope descent using the prosthetic leg. Place the heel of the prosthetic foot (approx. 1/3 of the foot) on the edge of the stair to flex the prosthetic knee using the yielding technique.
2. Load the prosthetic leg to initiate the descent mode.
3. The knee provides variable support while bending through it.
4. The knee swings forward when the prosthesis is unloaded.
5. Place the prosthetic foot onto the next step and continue descending using the step-over-step technique.
6. Repeat the process to continuously descend.

⚠ WARNING: Always use a handrail or other type of support when descending stairs/slopes.

⚠ WARNING: Ensure that about 1/3 of the prosthetic foot is on the edge of the step, to reliably trigger the stair descent functionality.

⚠ CAUTION: The device will give 4 vibrations if the knee gets overcharged due to continuous stair or slope descent after the device is fully charged.

⚠ CAUTION: Due to the knee torque being limited to 100Nm, the support for users above 80kg will not be sufficient during descent. Additional support is

needed from the arms for these users. If the slope descent function is not reliably activated, please contact your prosthetist to adjust the settings.

7.6. ASCENDING STAIRS

1. Stair ascent can best be initiated from a standing position, a more experienced user can initiate it from walking as well.
2. Initiate stair ascent by taking a step on the stair with a healthy leg. Progressively load the prosthetic leg from the heel to the toe and then lift the prosthetic leg up vertically with enough velocity.
3. The knee swings backward to provide toe clearance. Move the thigh forward only after the knee bends.
4. At the end of the swing phase, the knee automatically points the foot down allowing the wearer to ascend stairs of different heights.
5. Place the whole prosthetic foot on the next step.
6. Push off with the healthy leg, lean forward slightly and the knee starts to push the wearer up.
7. Extend the hip accordingly while the knee is extending.
8. Repeat and continue stair ascending until the end of the stairs.
9. At the end of the stair continue to walk normally, and the device will automatically switch to walking on a flat surface.
10. At the end of the stairs if the knee is still in the swing phase, raise the thigh until the knee points the foot to the floor and then lower the thigh till the prosthetic foot touches the ground. The device will now switch automatically to walking for the next step.

 **WARNING:** Always use a handrail when *ascending* stairs.

 **WARNING:** if the stair ascent behavior triggers when stepping up a single-step step-up (such as a curb or raised platform), put the prosthetic foot on the ground before taking further steps.

Note: Stopping halfway on the staircase or turning around is possible, ensure the foot is firmly placed on the staircase for the first step.

7.7. KNEELING DOWN AND GETTING UP

1. Place the prosthetic leg at the back and bend the knee to kneel on the prosthetic side, loading the prosthesis during the whole process.
2. Proceed to kneel on the sound side knee.
3. Turn about the knee on the sound side to sit on the floor.

4. You may extend the prosthetic knee while turning around or after you are seated on the floor.
5. The prosthetic leg will enter sleep mode after 3 seconds, the knee joint will have a low resistance after this.
6. To get up from the floor, turn towards the sound side and pivot to a kneeling position with both knees on the floor.
7. Use your hands and the sound leg to push off and stand up.
8. While standing up flex the hip on the prosthetic side to ensure that the prosthetic leg extends.
9. Load the prosthetic leg to check if the support is active before proceeding to walk.

7.8. CYCLING

1. Cycling can be best initiated from a standing position.
2. Left-sided amputees must stand on the right side and right-sided amputees must stand on the left side of the bike.
3. Two actions can be used to enter cycling mode, the device will give 2 beeps and 2 vibrations when successful.
 - a. Place the sound leg on the pedal and abduct the prosthetic leg by swinging it over the saddle.
 - b. Raise the thigh till the joint bends by its own weight. Use the hand to bend the joint further and place it on the pedal to enter cycling mode.
4. Start pedaling, after 2-3 crank rotations the Intuy Knee will start to power a portion of the rotation assisting the user.
5. When taking a pause, the device will have higher flexion resistance. Another 2 -3 crank rotations are needed for the device to start assisting the user.
6. Getting off the bike and exiting cycling mode can be done in two ways.
 - a. First, stand on the sound leg. Take the prosthetic leg off the pedal, it will have low resistance and the user needs to bring it into full extension and load it to enable the support from the knee. After loading it, swing it back over the saddle to exit spinning mode.
 - b. If it is not possible to swing the prosthetic leg over the saddle. After extending and loading the prosthesis to get

support, lean on the prosthesis and exit the bicycle using the sound leg. Take a step with the sound leg thus ensuring the prosthesis is inclined, load the forefoot and unload to exit from cycling mode and enter the walking mode.

⚠ CAUTION: Always remain seated while cycling, the joint will not provide support when cycling in a standing position.

8. INFORMATION SIGNALS OF THE DEVICE

This section contains the information signals given by Knee to the user. The Knee interacts with the user with 4 indicators, that is, an amber LED, a green LED, a buzzer, and the knee motor as a vibrator.

Mode or transition	Amber LED	Green LED	Buzzer	Vibrator
Power Off	Off	Off		
Sleep mode	Off	Fast flashing		
Operation mode	Off	On		
Lock-Knee mode	Fast flashing	Slow flashing		
High Resistance mode	Fast flashing	Slow flashing		
Battery low	Fast flashing	Slow flashing		
Battery critical low	Fast flashing	Slow flashing		
Standing mode--> cycling mode			2 beep	2 vibrations
Not Charging --> charging	Turns on	Turns Off		
Not charged --> fully charged	Turns off	Turns on		
Charger plugged in -->Charger unplugged	Turns off	Turns off		
Battery level ok --> Battery overcharged				4 vibrations

Mode or transition	Amber LED	Green LED	Buzzer	Vibrator
Batter level ok --> battery low	Fast flashing	Slow flashing	4s beeping	4 vibrations
Battery low --> battery critical low	Fast flashing	Slow flashing	8s beeping	8 vibrations
Powering on the device	Off	Fast flashing	2 ascending beeps	
Sleep mode --> operation mode	Off	On	3 ascending beeps	1 vibration
Motor error detected	Fast flashing	Slow flashing	5min beeping	
None-motor related error detected	Fast flashing	Slow flashing	8s beeping	8 vibrations
Mode change from the app			3 beeps	
Maintenance deadlines approaching (60 and 30 days)			15s beeping	15 vibrations
Maintenance deadline within 15 days			15s beeping	15 vibrations

9. TROUBLESHOOTING GUIDE

This section contains the troubleshooting guide with recommended actions. Whenever unexpected behaviors from the device are observed, connect to the device via the phone app, upload data, and contact your prosthetist.

Event	Potential Causes	Recommended Action
No LED is on	The device is in hibernation mode	Charge the device. Wait for a few seconds and check the LED. If LED is functional unplug the charger and power on the device.
No LED is on	LED malfunction; Power failure	Restart the device, and check if the buzzer beeps: If the buzzer beeps, it is a LED malfunction; If the buzzer does not beep, it is a power failure. Either way, contact your prosthetist
The Knee behaves unexpectedly, Green LED is on	Undetected sensor failure; Incorrect calibration	Restart the device. If the problem persists, power it off. Do not use the device further. Upload data via the app. Contact your prosthetist.
Knee does not go to the swing phase and stays in High Resistance mode; an amber LED is flashing	The battery is critically low; Errors are detected;	Charge the device for 30 minutes, disconnect the charger, and power on the device. If the device still does not work, upload data via the app. Do not use the device further, contact your prosthetist.
Stair mode does not trigger despite the correct user cue	Incorrect calibration of the sensor	Contact your prosthetist to re-calibrate the sensors
Error message in the app; the knee vibrates and makes sounds	Errors are detected	Contact your prosthetist

10. MAINTENANCE, TRANSPORTATION, STORAGE, AND DISPOSAL

10.1. MANUFACTURER MAINTENANCE

- Periodic maintenance at the manufacturer's location is compulsory every twelve months or when the Knee has made 960,000 movements.
- The knee and the app provide reminder signals or messages to the user. Reminders emails are also sent to the user including the user's prosthetist. Refer to the Section "Information Signals of the Device" for the exact signals from the Knee.
- Both the device and the charger must be sent in for maintenance and repair work. Use the original packaging when sending the device.
- Contact your prosthetist to schedule the maintenance.

⚠WARNING: Follow the recommended maintenance intervals. Not maintaining the product timely can cause damage to the device and the user, and will void the warranty.

10.2. USER MAINTENANCE AND CLEANING

- The Charger is maintenance-free.
- The Knee has no user-maintainable parts.
- Keep the device dry and clean to prevent potential hardware degradation.
- Clean with a lightly damp cloth when necessary. Allow it to air dry fully.
- Do not purposely immerse the device in water when cleaning and dry the device after cleaning.
- Do not remove the lubricants on the ballscrew, clean with a clean cloth if it is spilled on the device body.
- If water does get into the device, please dry the outside and make sure water gets out from the drain hole (see the figure). And allow it to air dry fully.

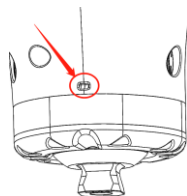

⚠CAUTION: If the device is not dried after being immersed in water, it may result in hardware degradation and introduce risks.

⚠ CAUTION: Dust, particles, or other contamination of the internal parts of the device may affect the performance of the device.

⚠ CAUTION: Do not oil, grease, lubricate or use any other chemicals on the device. If it is noisy, damaged, or broken, contact the local Representative of the Manufacturer to make a repair appointment.

⚠ CAUTION: Do not use any tools to modify the device.

⚠ CAUTION: Do not try to remove screws or try to disassemble the device.

10.3. TRANSPORTATION AND STORAGE

- The device including its accessories should be stored and transported using its original packaging, in a cool and dry environment. The temperatures should be between 0°C and 40°C. The humidity level should be between 10% to 90% RH, non-condensing.
- Do not transport in a harsh environment. Do not expose to extreme coldness, heat, or humidity.
- Handle with care during transportation.
- Avoid storing a fully charged device for extended periods.

10.4. DISPOSAL

- Do not dispose of the device as regular garbage, since the Li-ion battery is integrated inside.
- For device disposal, please contact the Manufacturer's local Representative or the Manufacturer (if the local Representative is not designated).

11. WARRANTY, SERVICE LIFE, LIABILITY, AND INCIDENT REPORTING

11.1. WARRANTY AND SERVICE LIFE

The service life of the device is designed to be at least 3 years.

Performing maintenance timely can increase the service life to 6 years. An extended warranty can be purchased separately. Contact your prosthetist for purchasing instructions.

The following are not covered by the warranty:

- Repairs resulting from misuse, careless handling, or intentional damage.

	Instructions for Use (Wearer)		DOC-66
	Basic UDI-DI: 87202994598ILK98	Ver. 2.0.7, 2022/11/04	33 / 35

- Repairs when the user doesn't follow the maintenance schedule.
- The warranty is void if modification or disassembly has been done by unauthorized personnel.

11.2. LIABILITY

The manufacturer is not liable for the following situations:

- The device is used outside of the intended purpose or use conditions.
- The device is not maintained according to the Instructions for Use.
- The device is used with components not authorized by the manufacturer.

11.3. SERIOUS INCIDENT REPORTING

For users established in the EU, serious incidents in relation to the device must be reported to the Manufacturer and the competent authority of the Member State in which the user is established.

A "serious incident" is any incident that caused, may have caused, or may cause, directly or indirectly, one of the following consequences:

- death of a patient, user, or other persons;
- temporary or permanent health deterioration of a patient, user, or other persons;
- a serious public health threat.

12. PRODUCT CERTIFICATION INFORMATION

The product has been tested or assessed and found to comply with the standards listed below.

- EN-IEC 60601-1:2006+AC:2010+A1:2013+A12:2014
- EN-IEC 60601-1-2:2015
- EN ISO 10328:2016

The product complies with European regulations such as Regulation (EU) 2017/745 (MDR) and has obtained the CE mark after being assessed by a notified body.

The manufacturer's Quality Management System (QMS) is certified according to Regulation (EU) 2017/745 (MDR) and EN ISO 13485:2016+C11:2017+C12:2018+A11:2021.

	Instructions for Use (Wearer)		DOC-66
	Basic UDI-DI: 87202994598ILK98	Ver. 2.0.7, 2022/11/04	34 / 35

12.1. EN-IEC 60601-1:2006+AC:2010+A1:2013+A12:2014

The device has been tested and found to comply with this standard (EN-IEC 60601-1:2006+AC:2010+A1:2013+A12:2014, Medical electrical equipment – Part 1: General requirements for basic safety and essential performance).

12.2. EN-IEC 60601-1-2:2015

The device has been tested and found to comply with this standard (EN-IEC 60601-1-2:2015, Medical electrical equipment – Part 1-2: General requirements for basic safety and essential performance – Collateral Standard: Electromagnetic disturbances – Requirements and tests).

12.3. EN ISO 10328:2016

Intuy Knee is tested and rated to P6 level for 125kg maximal body weight according to EN ISO 10328:2016.

12.4. BLUETOOTH MODULE

This device contains the following radio frequency transmitters:

Model	Frequency characteristics	Effective radiated power
Bluetooth 4.2 low energy: BGM121	2400~2483.5MHz	+8 dBm

13. CONTACT INFORMATION

13.1. MANUFACTURER



Rebocon Bionics B.V.
 Rotterdamseweg 386 B1,
 2629 HG, Delft,
 the Netherlands
www.rbionics.com

13.2. DISTRIBUTOR OR RETAILER

The Distributors or Retailers of the Product shall place their contact information sticker below. The user should always contact them first before contacting the Manufacturer.

